

DTF-3/103/300

SERVICE MANUAL

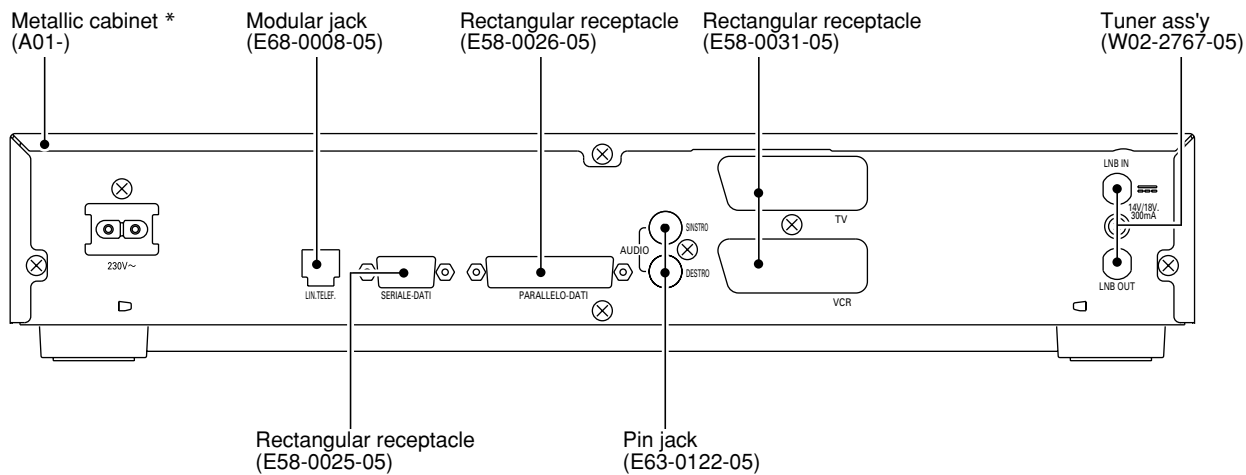
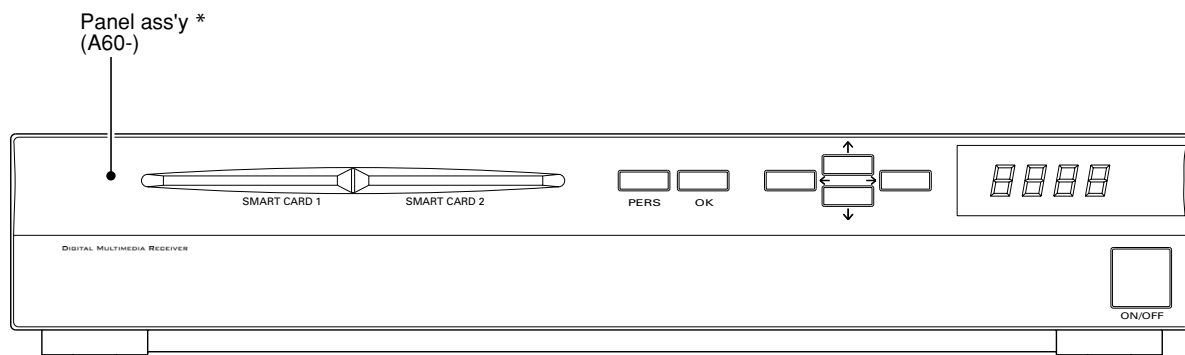

liiust. is DTF-3.

* Refer to parts list on page 17.











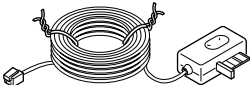

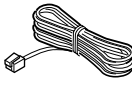

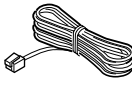

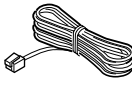

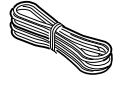

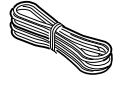

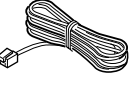
DTF-3/103/300

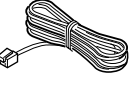
CONTENTS / ACCESSORIES

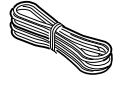
Contents

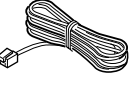
CONTENTS / ACCESSORIES	2	SCHEMATIC DIAGRAM	8
CONTROLS	3	EXPLODED VIEW	16
PC BOARD	6	PARTS LIST	17

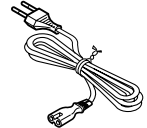
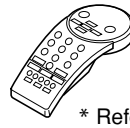
Accessories

<p>Cord with connector (E30-2917-05) (France) type</p> 	<p>Cord with connector (E30-2976-05) (Italy) type</p> 	<p>(Netherlands) type</p> <table border="0"> <tr> <td> <p>Cord with connector (E30-2996-05)</p>  </td> <td> <p>Adapter (W01-0987-05)</p>  </td> </tr> </table>		<p>Cord with connector (E30-2996-05)</p> 	<p>Adapter (W01-0987-05)</p> 		
<p>Cord with connector (E30-2996-05)</p> 	<p>Adapter (W01-0987-05)</p> 						
<p>(Poland) type</p> <table border="0"> <tr> <td> <p>Cord with connector (E30-2996-05)</p>  </td> <td> <p>Adapter (W01-0978-05)</p>  </td> </tr> </table>		<p>Cord with connector (E30-2996-05)</p> 	<p>Adapter (W01-0978-05)</p> 	<p>(Spain) type</p> <table border="0"> <tr> <td> <p>Cord with connector (E30-2996-05)</p>  </td> <td> <p>Adapter (W01-0986-15)</p>  </td> </tr> </table>		<p>Cord with connector (E30-2996-05)</p> 	<p>Adapter (W01-0986-15)</p> 
<p>Cord with connector (E30-2996-05)</p> 	<p>Adapter (W01-0978-05)</p> 						
<p>Cord with connector (E30-2996-05)</p> 	<p>Adapter (W01-0986-15)</p> 						
<p>AC power cord (INLET) (E30-2948-05)</p> 	<p>Remote controller ass'y *</p>  <p>* Refer to parts list.</p>	<p>Cord with connector (E30-2975-05)</p> 	<p>Batteries</p> 				

Model	Country	Tuner	Abb
DTF-3	France	X05-5172-70	F1
DTF-3	Poland	X05-5172-71	P1
DTF-3	Italy	X05-5172-72	I1
DTF-3	Spain	X05-5172-73	S1
DTF-103	Italy	X05-5172-74	I5
DTF-300	France	X05-5172-75	F3
DTF-300	Poland	X05-5172-76	P3
DTF-300	Italy	X05-5172-77	I3
DTF-300	Netherland	X05-5172-78	N3
DTF-300	Spain	X05-5172-79	S3
SMB 2700 PLUS	Italy	X05-5172-77	I7

DTF-3/103/300

CONTROLS (DTF-3)

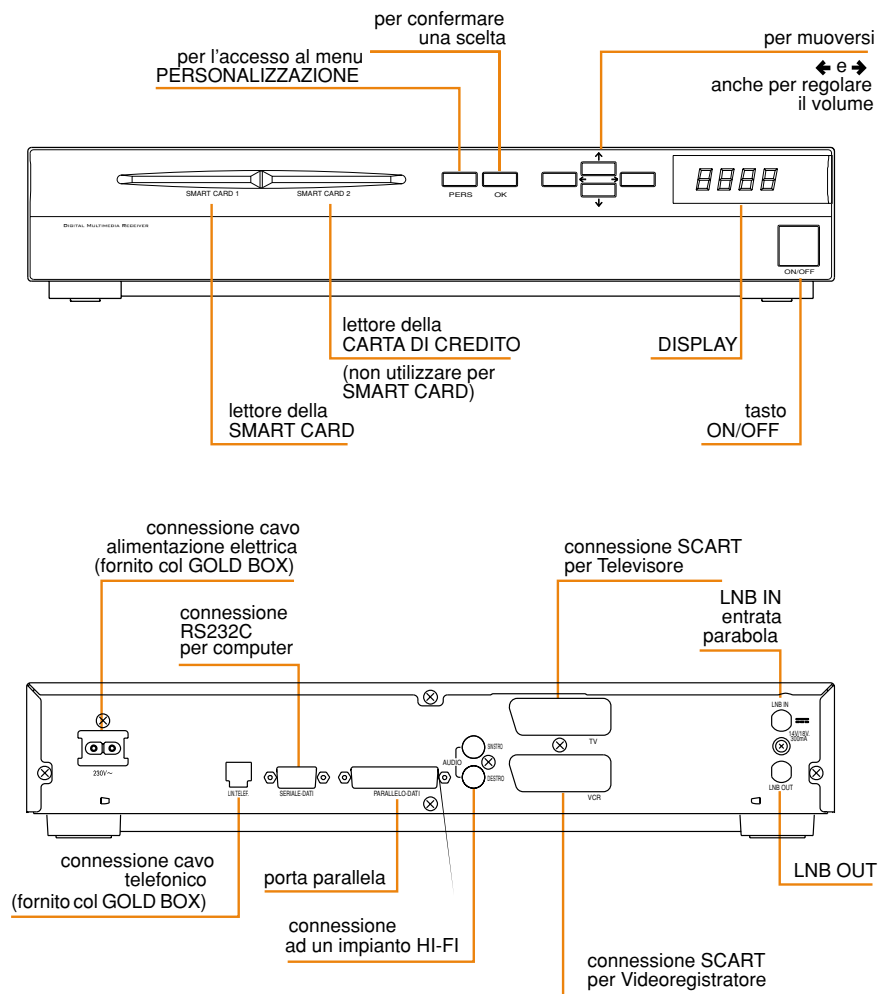
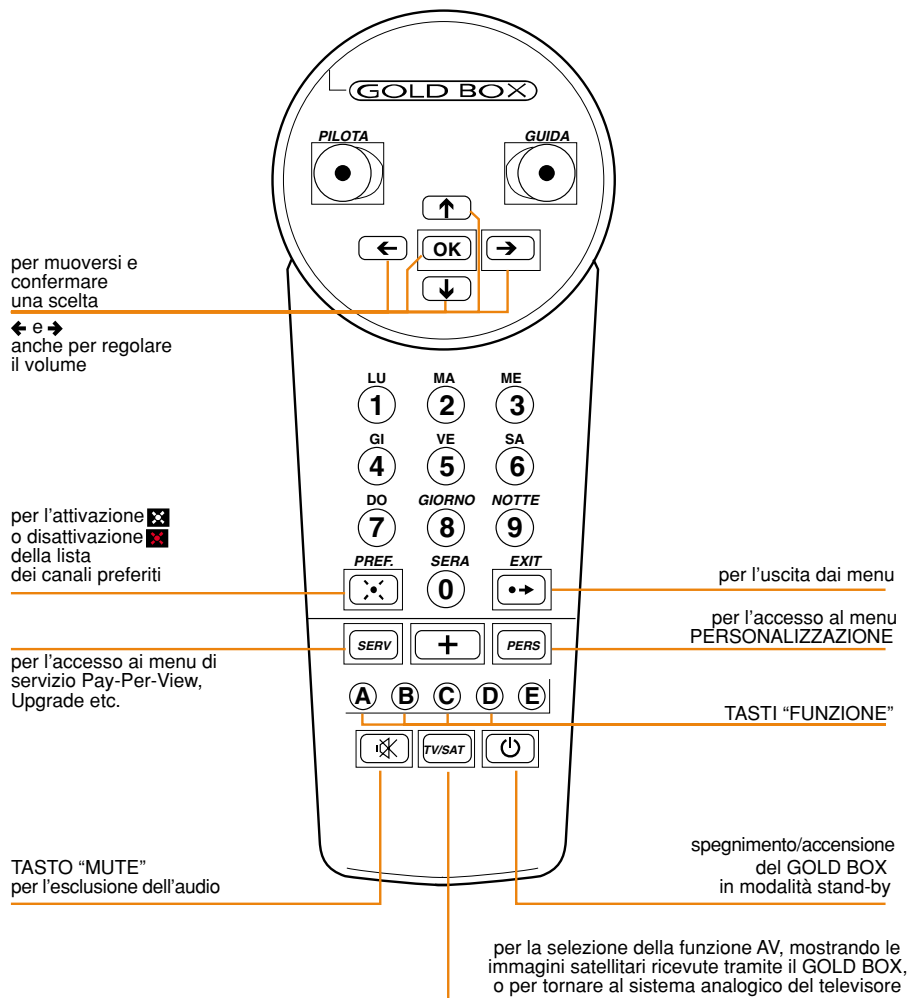

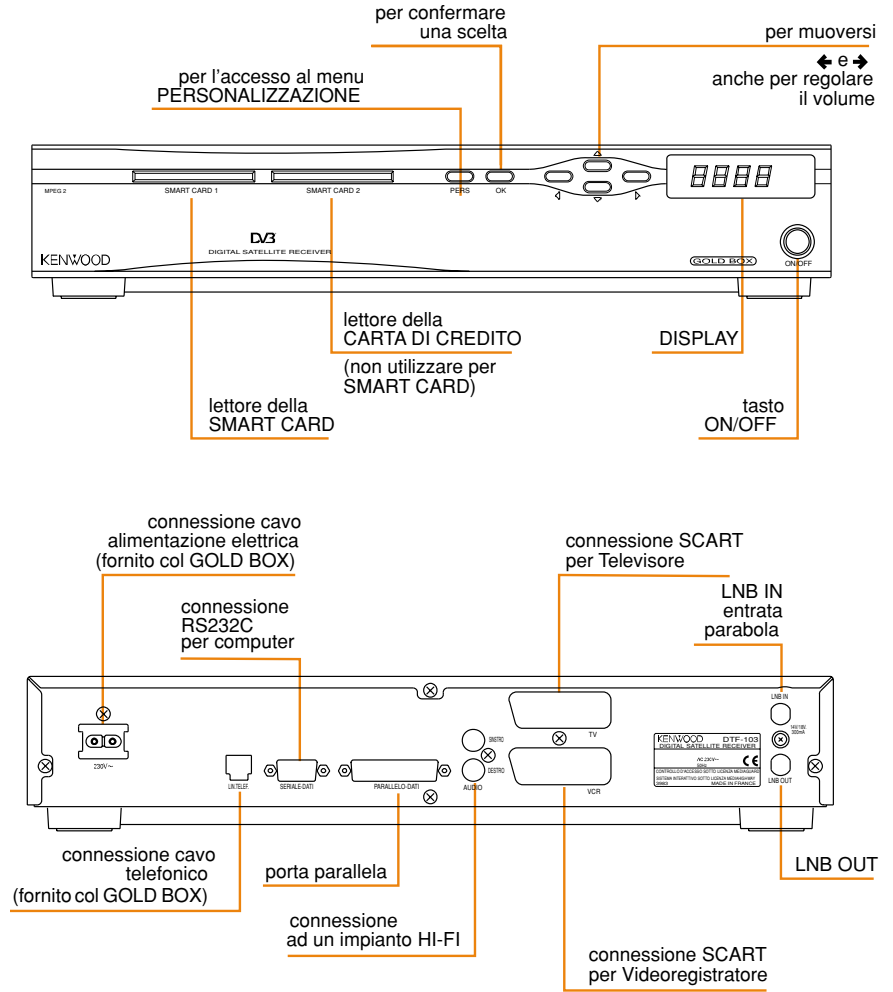
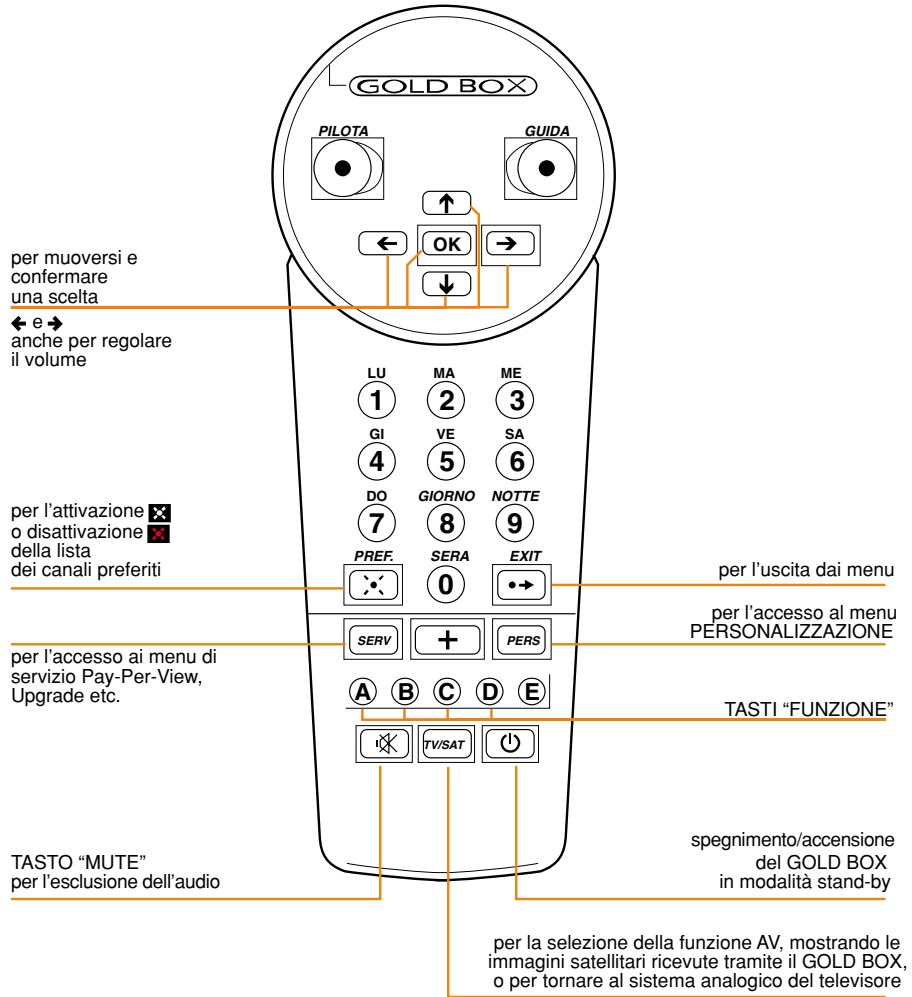

DTF-3/103/300

CONTROLS (DTF-103)

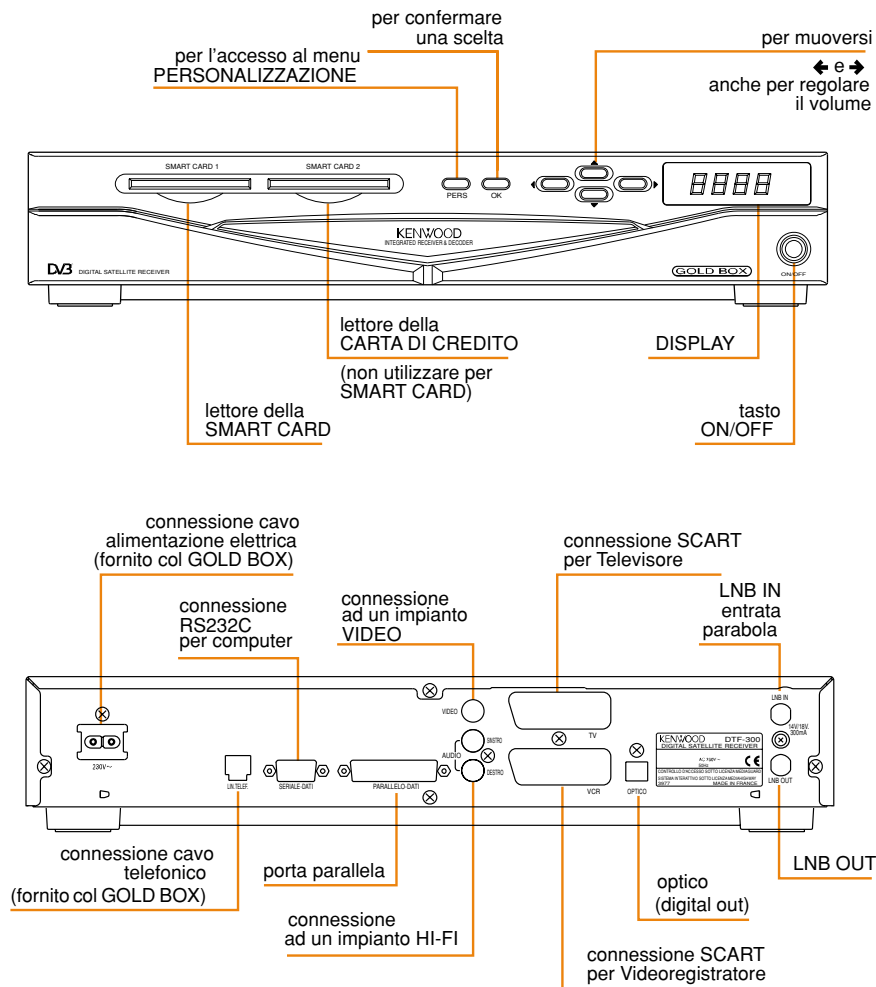
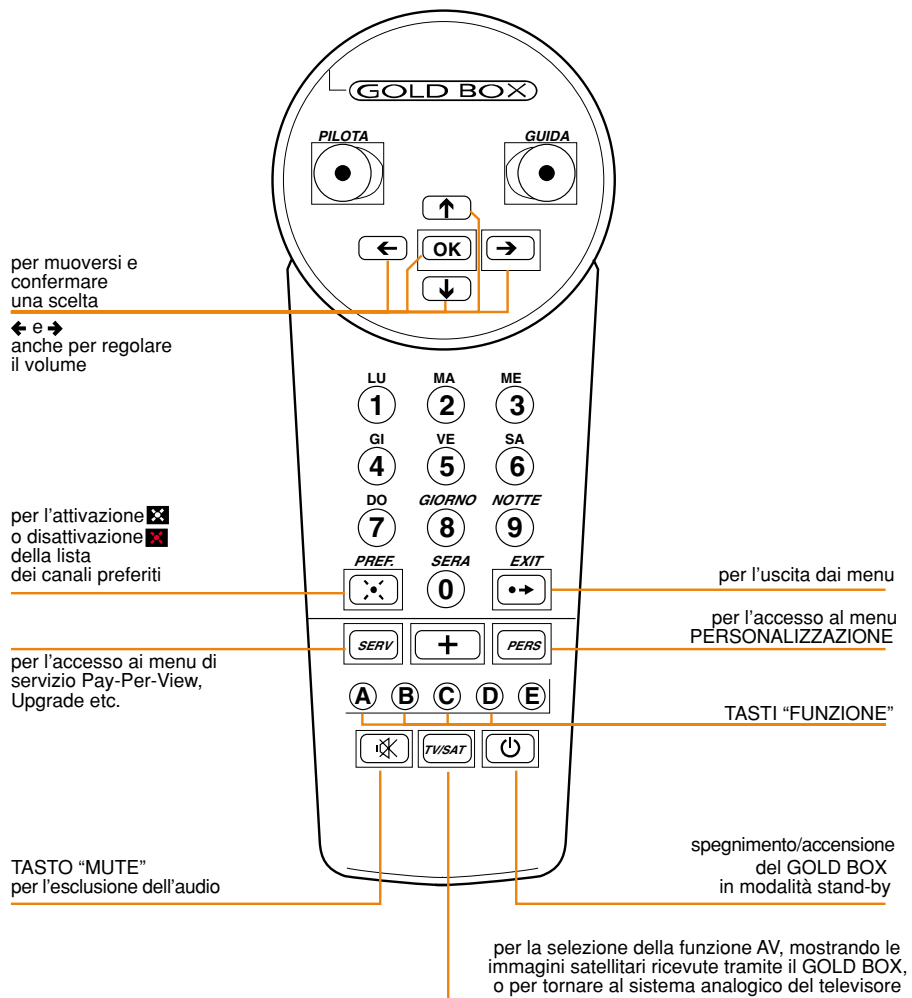

CONTROLS (DTF-300)

DTF-3/103/300

PC BOARD(Component side view)

X14 B/2

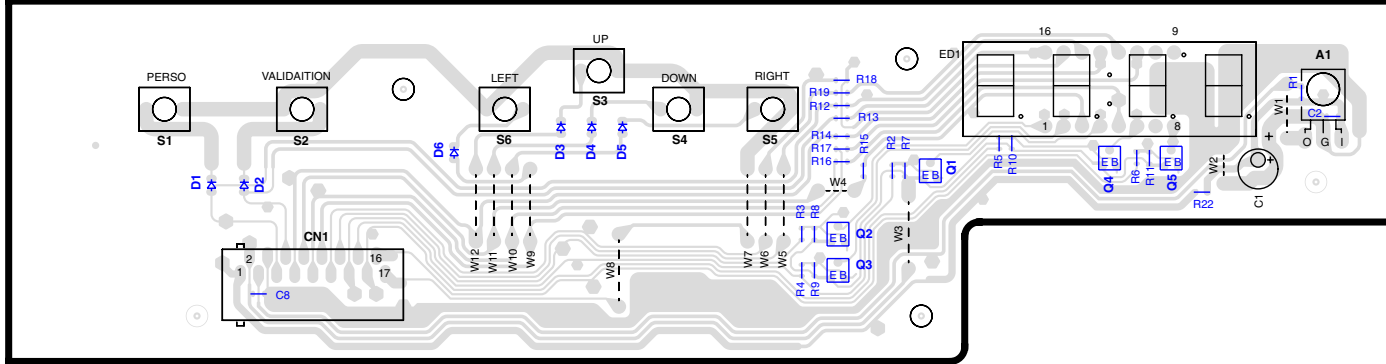

X14-7242-70 A/2 (J70-1454-12)

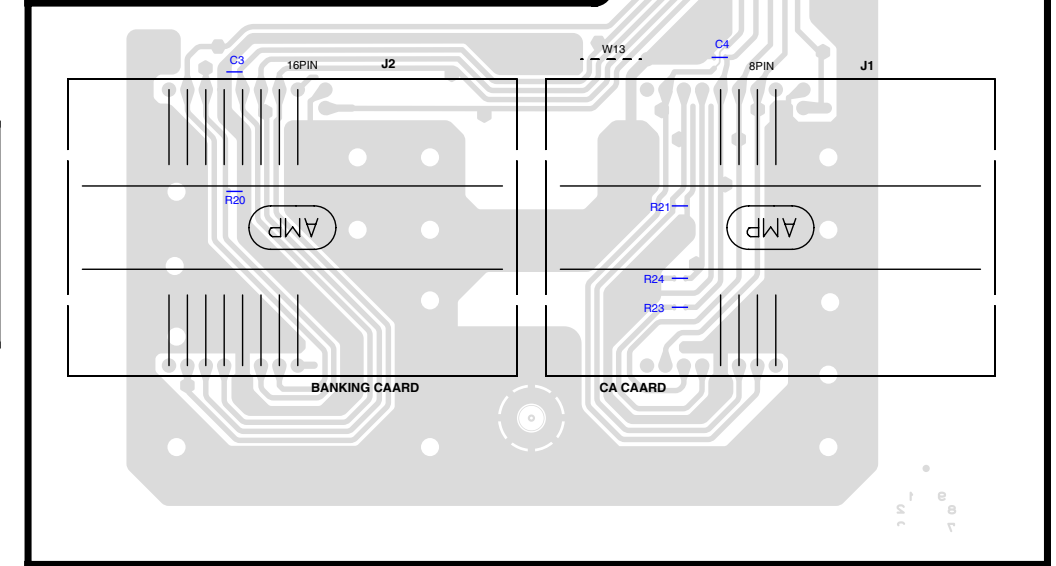

X05-517 (J70-1443-11)

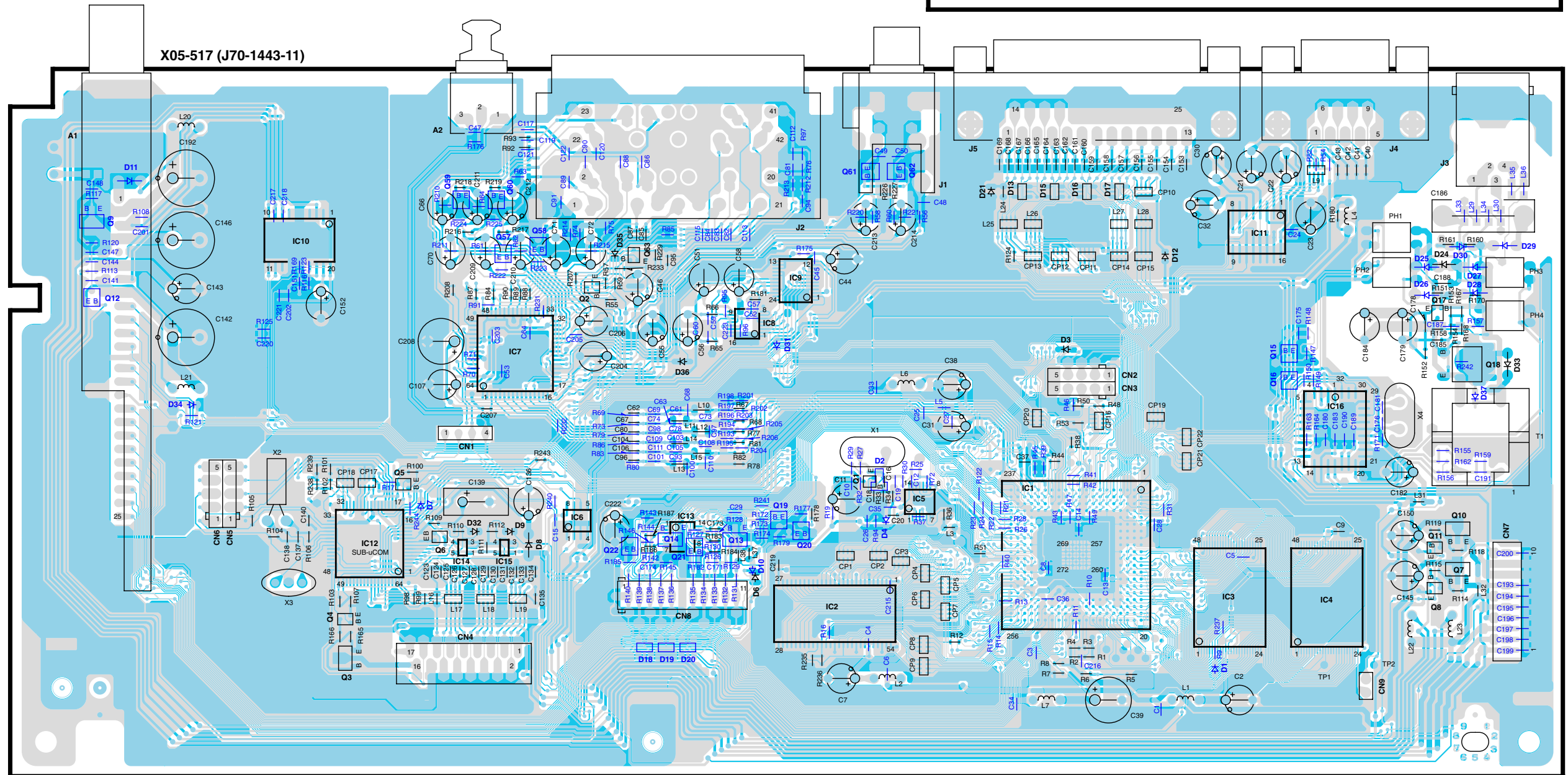

Refer to the schematic diagram for the value of resistors and capacitors.

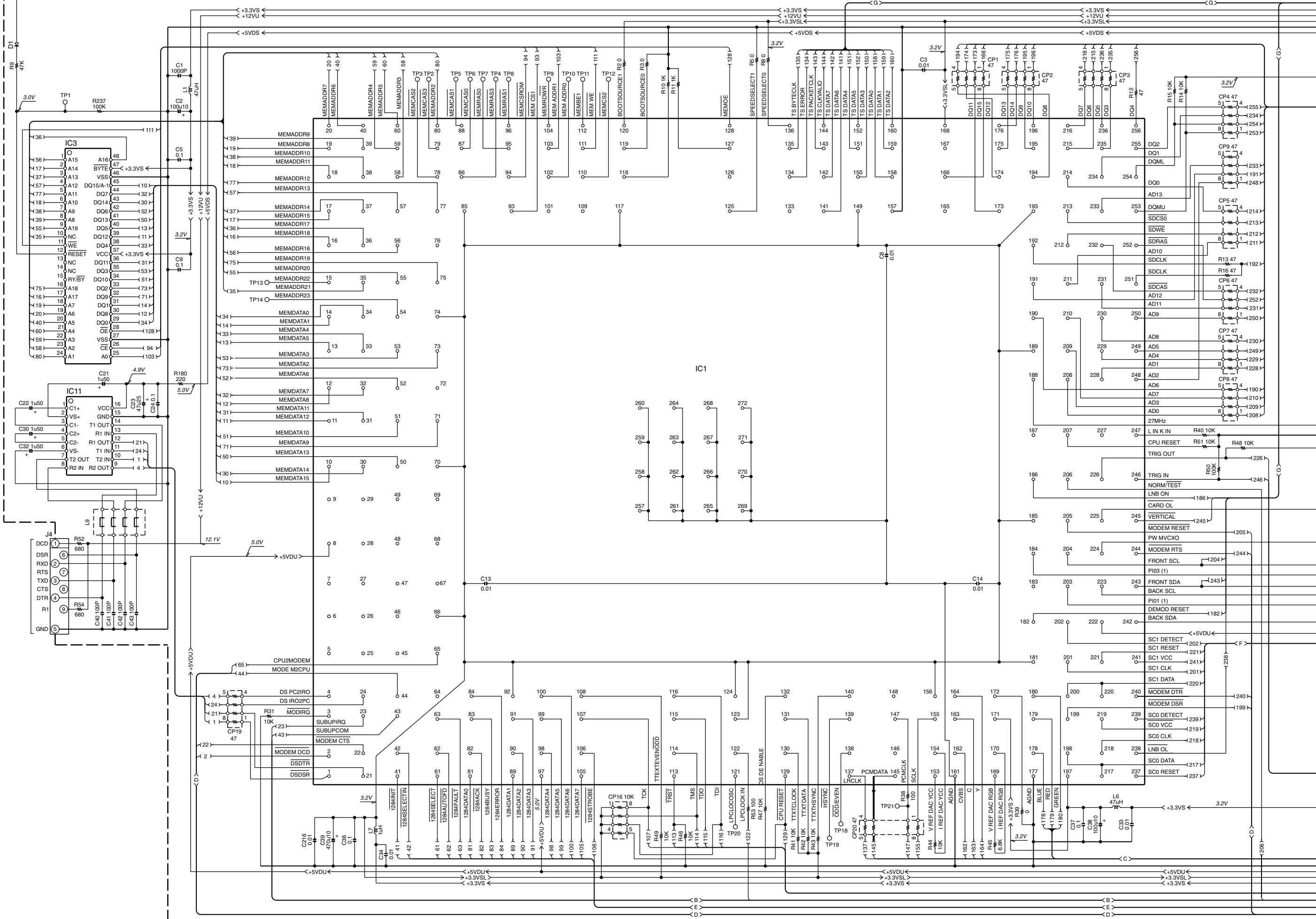

A
B
C
D
E
F
G
H
I
J

D1
D
D
D
D
D
D
D
D
D

1
2
3
4
5
6
7

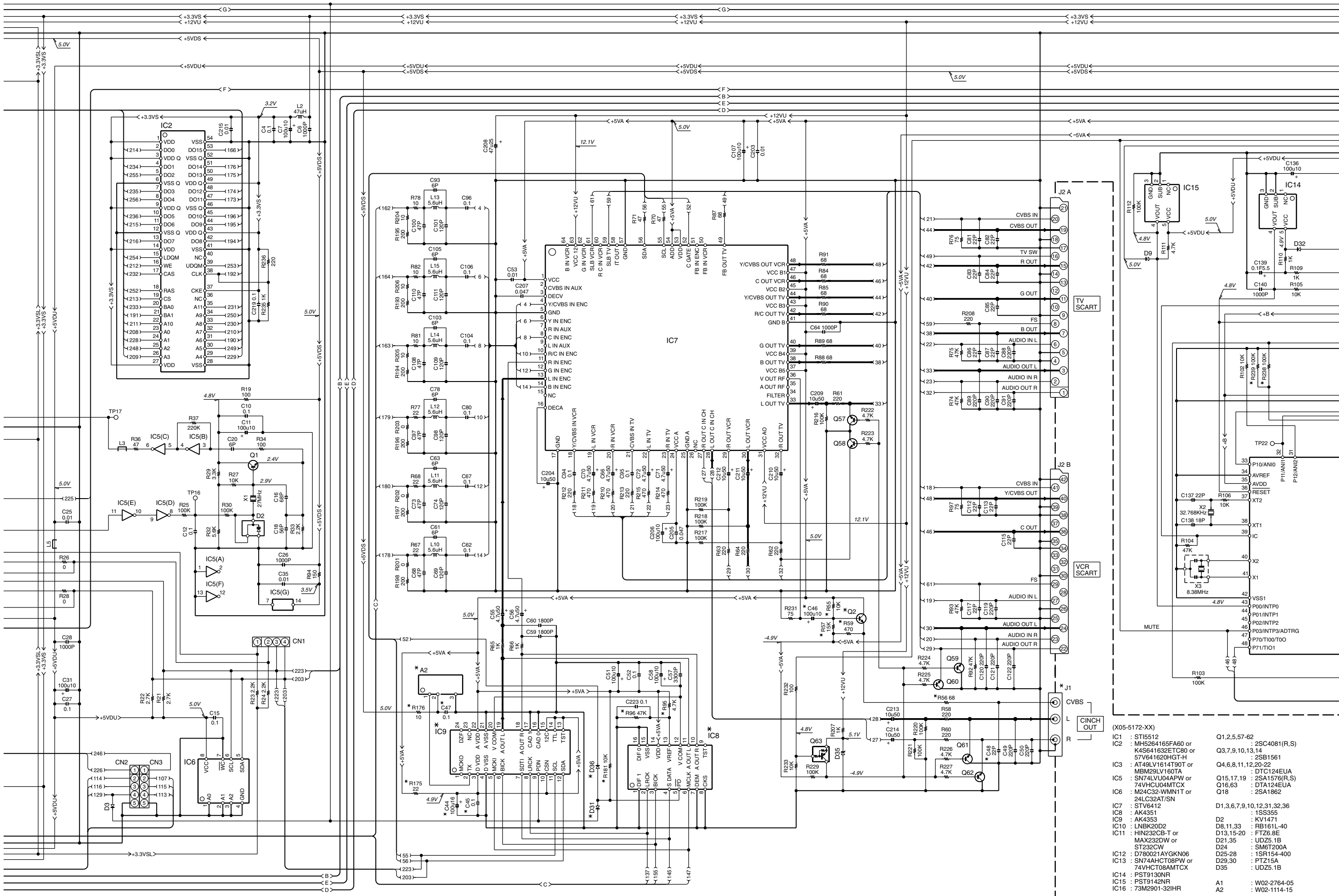

(X05-5172-XX)

IC1 : ST15512	Q1,2,5,57-62
IC2 : MH5264165FA60 or K4S641632ETC80 or 57V641620HGT-H	Q3,7,9,10,13,14 : 2SC4081(R,S) : 2SB1561
IC3 : AT49LV1614T90T or MBM29LV160TA	Q4,6,8,11,12,20-22 : DTC124EUA : DTA124EUA
IC5 : SN74LVU04APW or 74VHC04MTCX	Q15,17,19 : 2SA1576(R,S) : 2SA1862
IC6 : M24C32-WMNT1T or 24LC32AT/5N	Q18 : 2SA1862
IC7 : STV6412	D1,3,6,7,9,10,12,31,32,36
IC8 : AK4351	: 15S355
IC9 : AK4353	: KV1471
IC10 : LNBK20D2	D8,11,33 : RB161L-40
IC11 : HIN232CB-T or MAX232DW or ST232CW	D13,15-20 : FTZ6.8E D21,35 : UDZ5.1B D24 : SMGT200A
IC12 : D780021AYGKN06	D25-28 : 1SR154-400
IC13 : SN74AHC08PW or 74VHC08AMTCX	D29,30 : PTZ15A D35 : UDZ5.1B
IC14 : PST9130NR	A1 : W02-2764-05
IC15 : PST9142NR	A2 : W02-1114-15
IC16 : 73M2901-32IHR	

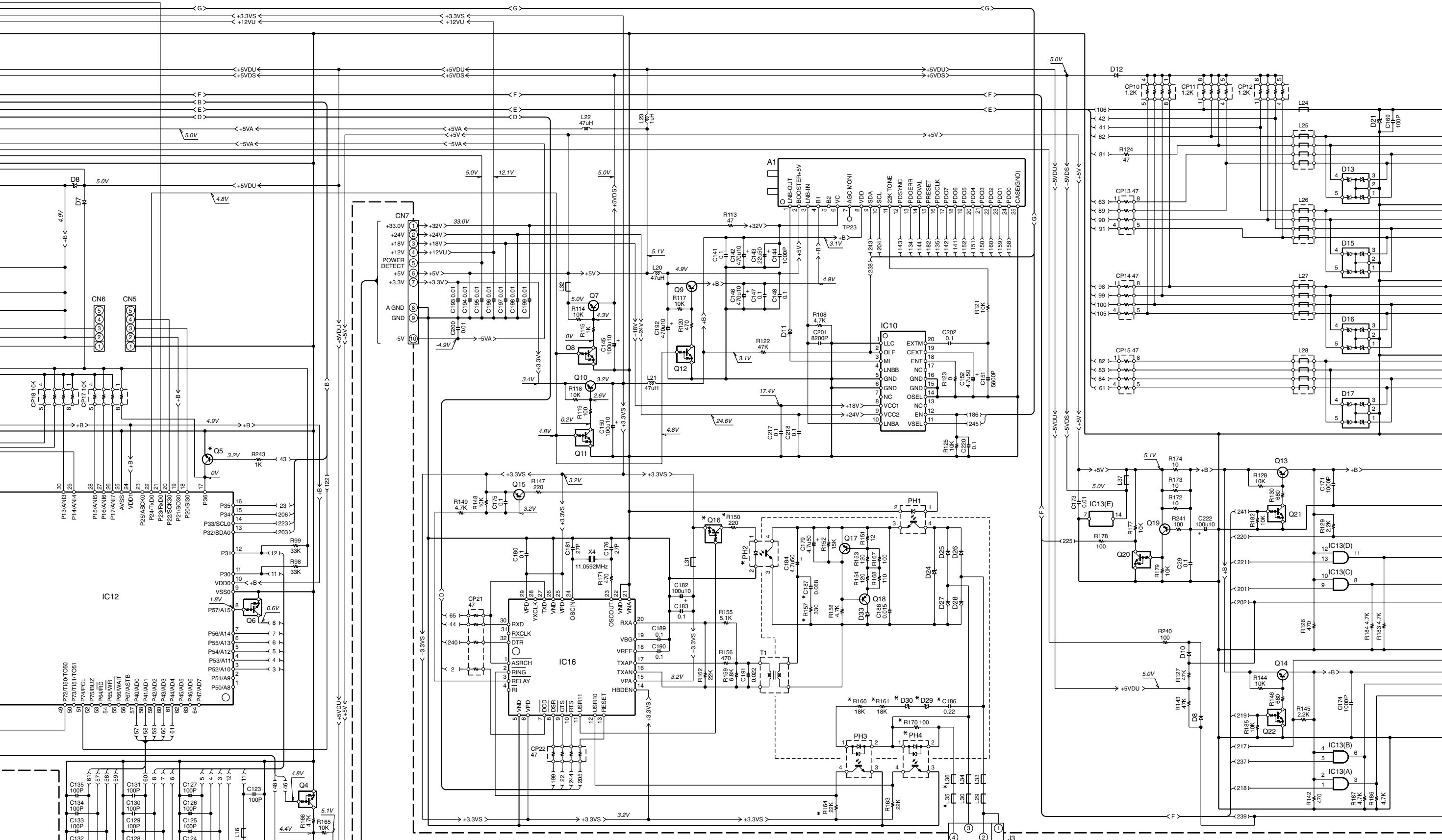

DTF-3 (X05-5172-XX)

DESTINATION COUNTRY	ABB.	UNIT No.	A2	C44-48	C186, 187	D29, 30	D31, 36	IC8	IC9	J1	L35, 36	PH4	PH2	Q2, 5	Q16	R55-57, 59, 175, 176	R95, 96, 181	R150, 238	R157, 160, 161, 164	R170, 239
FRANCE	F1	2-70			YES	YES					YES	YES	NO	NO	NO			NO	YES	YES
POLAND	P1	2-71	NO	NO	NO	NO				E63-0122-05	NO	NO	YES	NO	NO			NO	NO	YES
ITALY	I1	2-72			YES	YES					NO	NO	YES	NO	NO			YES	YES	NO
SPAIN	S1	2-73			YES	YES					NO	NO	YES	NO	NO			YES	YES	NO

DTF-103 (X05-5172-74)

DESTINATION COUNTRY	ABB.	UNIT No.	A2	C44-48	C186, 187	D29-31, 36	IC8	IC9	J1	L35, 36	PH4	PH2	Q2, 5	Q16	R55-57, 59, 170, 175, 176, 239	R95, 96, 150, 157, 160, 161, 164, 181, 238
ITALY	I5	2-74	NO	NO	YES	YES	YES	NO	E63-0122-05	NO	NO	YES	NO	YES	NO	YES

DTF-300 (X05-5172-XX)

DESTINATION COUNTRY	ABB.	UNIT No.	A2	C44-48	C186, 187	D29, 30	D31, 36	IC8	IC9	J1	L35, 36	PH4	PH2	Q2, 5	Q16	R55-57, 59, 175, 176	R95, 96, 181	R150, 238	R157, 160, 161, 164	R170, 239	R238
FRANCE	F3	2-75			YES	YES					YES	YES	NO	NO	NO			NO	YES	YES	NO
POLAND	P3	2-76			NO	NO					NO	NO	YES	NO	NO			YES	NO	NO	NO
ITALY	I3	2-77	YES	YES	YES	YES	NO	NO	YES	E63-1168-05	NO	NO	YES	YES	YES	YES	NO	NO	NO	NO	NO
NETHERLAND	N3	2-78			YES	YES					NO	NO	NO	NO	NO			NO	YES	NO	YES
SPAIN	S3	2-79			YES	YES					NO	NO	YES	YES	YES			YES	NO	NO	YES

SMB 2700 (X05-5172-77)

DESTINATION COUNTRY	ABB.	UNIT No.	A2	C44-48	D29, 30	D31, 36	IC8	IC9	J1	L35, 36	PH4	PH2	Q2, 5, 16	R55-57, 59, 150, 157, 160, 161, 164, 175, 176, 238	R95, 96, 170, 181, 239
ITALY	I7	2-77	YES	YES	YES	NO	NO	YES	E63-1168-05	NO	NO	YES	YES	YES	NO

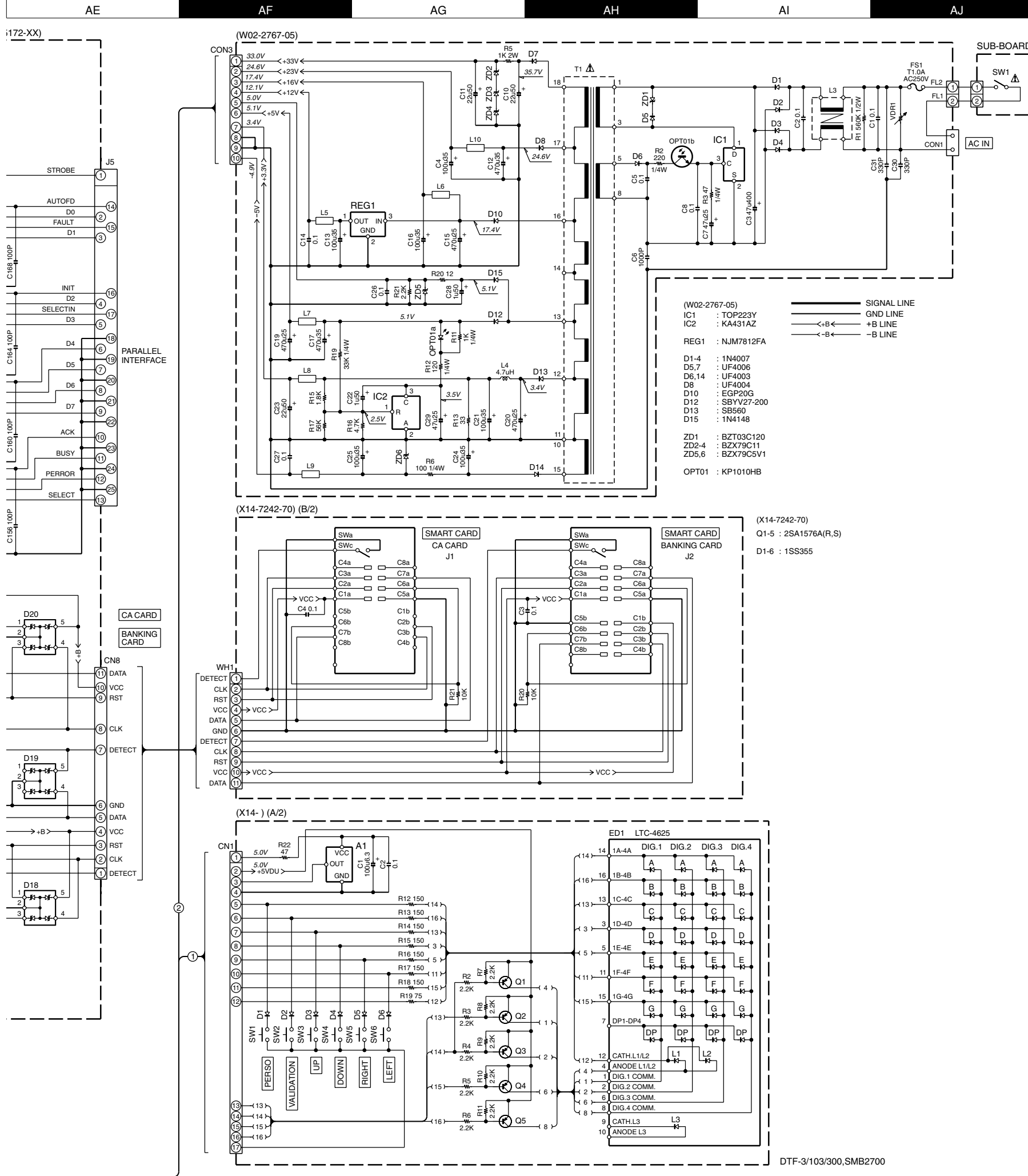

CAUTION: For continued safety, replace safety critical components only with manufacturer's recommended parts (refer to parts list). Δ indicates safety critical components. For continued protection against risk of fire, replace only with same type and rating fuse(s). To reduce the risk of electric shock, leakage-current or resistance measurements shall be carried out (exposed parts are acceptably insulated from the supply circuit) before the appliance is returned to the customer.

The DC voltage is an actual reading measured with a high impedance type voltmeter with no signal input. The measurement value may vary depending on the measuring instruments used or on the product.

DTF-3/103/300

KENWOOD

Y07-3912-70

DTF-3/103/300,SMB2700

DTF-3/103/300

EXPLODED VIEW (UNIT)

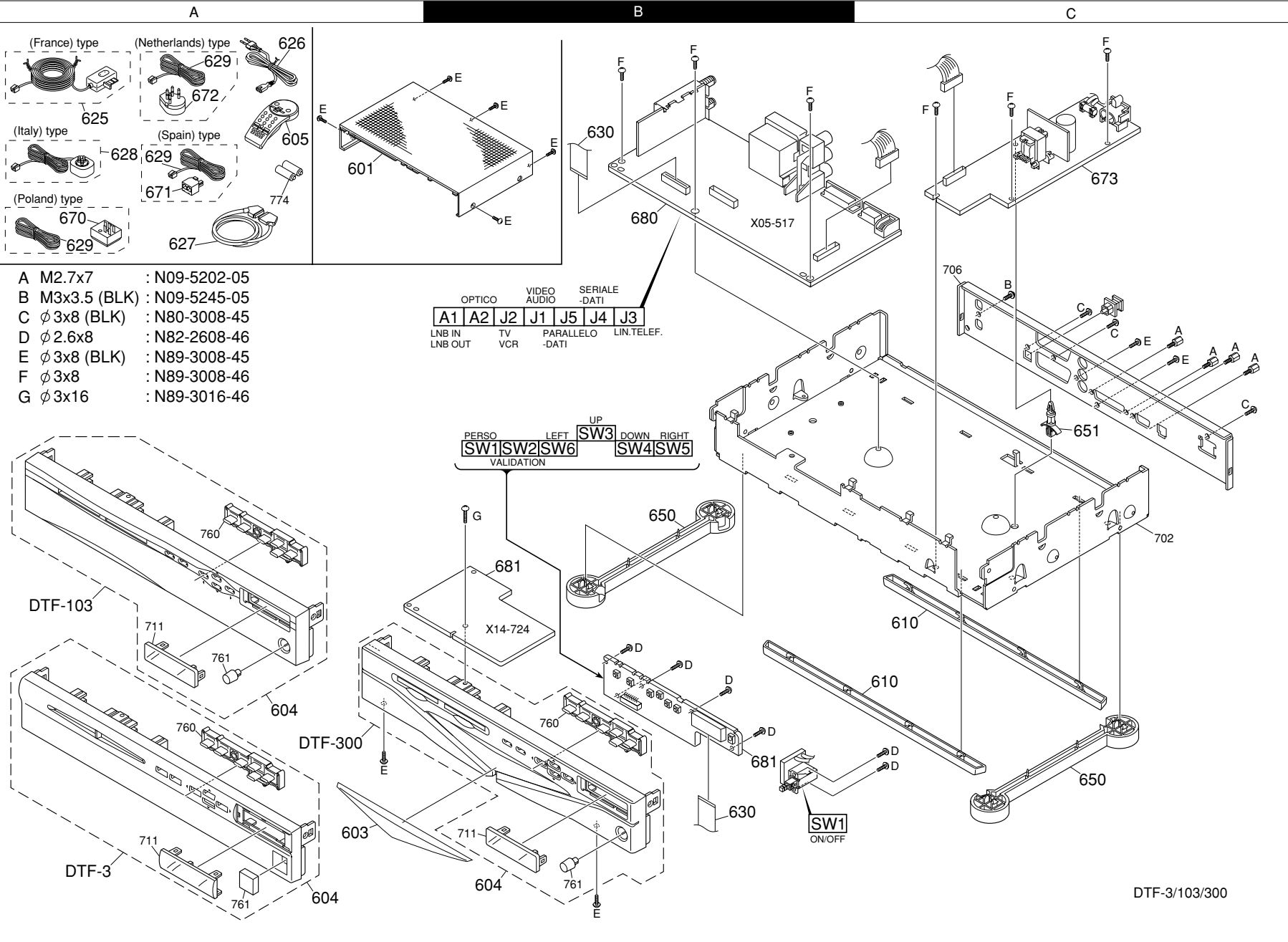

Parts with exploded numbers larger than 700 are not supplied.

* New Parts
Parts without **Parts No.** are not supplied.
Les articles non mentionnés dans le **Parts No.** ne sont pas fournis.
Teile ohne **Parts No.** werden nicht geliefert.

①

Ref. No	Add-ress	New Parts	Parts No.	Description	Desti-nation	Re-marks
DTF-300						
601	1A		A01-3784-01	METALLIC CABINET		
603	2A		A21-3825-03	DRESSING PANEL		
604	2B		A60-1809-32	PANEL ASSY	F3	
604	2B		A60-1810-32	PANEL ASSY	I3	
604	2B		A60-1812-22	PANEL ASSY	S3	
604	1B		A60-1814-42	PANEL ASSY	N3	
604	1B		A60-1874-22	PANEL ASSY	P3	
605	1A		A70-1324-05	REMOTE CONTROLLER ASSY	I3	
605	1A		A70-1364-05	REMOTE CONTROLLER ASSY	F3	
605	1A		A70-1365-15	REMOTE CONTROLLER ASSY	S3	
605	1A		A70-1366-05	REMOTE CONTROLLER ASSY	N3	
605	1A		A70-1421-05	REMOTE CONTROLLER ASSY	P3	
-			B59-1447-00	SUB-INSTRUCTION MANUAL	P3	
-			B59-1450-00	SUB-INSTRUCTION MANUAL	S3	
-			B60-4802-00	INSTRUCTION MANUAL	F3	
-			B60-4803-00	INSTRUCTION MANUAL	F3	
-			B60-4804-00	INSTRUCTION MANUAL	P3	
-			B60-4805-00	INSTRUCTION MANUAL	P3	
-			B60-4806-00	INSTRUCTION MANUAL	I3	
-			B60-4808-00	INSTRUCTION MANUAL	N3	
-			B60-4809-00	INSTRUCTION MANUAL	N3	
-			B60-4810-00	INSTRUCTION MANUAL	S3	
-			B60-4811-00	INSTRUCTION MANUAL	S3	
△ 625	1A		E30-2917-05	CORD WITH CONNECTOR	F3	
626	1A		E30-2948-05	AC POWER CORD (INLET)		
627	1A		E30-2975-05	CORD WITH CONNECTOR		
628	1A		E30-2976-05	CORD WITH CONNECTOR	I3	
629	1A		E30-2996-05	CORD WITH CONNECTOR	P3N3S3	
630	1B,2B		E35-2811-05	FLAT CABLE		
-			H10-7640-02	POLYSTYRENE FOAMED FIXTURE		
-			H10-7641-02	POLYSTYRENE FOAMED FIXTURE		
-			H13-0331-04	CARTON BOARD		
-			H25-0232-04	PROTECTION BAG (235X350X0.03)		
-			H25-1689-04	PROTECTION BAG		
-			H50-3883-04	ITEM CARTON CASE	F3	
-			H50-3884-04	ITEM CARTON CASE	P3	
-			H50-3885-04	ITEM CARTON CASE	I3	
-			H50-3886-04	ITEM CARTON CASE	N3	
-			H50-3887-04	ITEM CARTON CASE	S3	
650	2B,2C		J02-1493-03	FOOT ASSY		
651	1C		J19-3326-15	UNIT HOLDER		
-			J61-0307-05	WIRE BAND		
670	1A		W01-0978-05	ADAPTER	P3	
671	1A		W01-0986-15	ADAPTER	S3	
672	1A		W01-0987-05	ADAPTER	N3	
673	1C		W02-2767-05	ELECTRIC CIRCUIT MODULE		
680	1B		X05-5172-75	TUNER UNIT	F3	
680	1B		X05-5172-76	TUNER UNIT	P3	
680	1B		X05-5172-77	TUNER UNIT	I3	
680	1B		X05-5172-78	TUNER UNIT	N3	
680	1B		X05-5172-79	TUNER UNIT	S3	
681	2B		X14-7242-70	DISPLAY UNIT		

△ indicates safety critical components.

* New Parts
Parts without **Parts No.** are not supplied.
Les articles non mentionnés dans le **Parts No.** ne sont pas fournis.
Teile ohne **Parts No.** werden nicht geliefert.

②

Ref. No	Add-ress	New Parts	Parts No.	Description	Desti-nation	Re-marks
DTF-3/DTF-103						
601	1A		A01-3784-01	METALLIC CABINET		I5
601	1A		A01-3786-01	METALLIC CABINET		F1P1S1
601	1A		A01-3787-01	METALLIC CABINET		I1
601	1A		A01-3819-01	METALLIC CABINET		I7
604	2A		A60-1797-12	PANEL ASSY		F1
604	2A		A60-1798-12	PANEL ASSY		P1
604	2A		A60-1817-02	PANEL ASSY		S1
604	2A		A60-1902-22	PANEL ASSY		I5
604	2A		A60-2061-02	PANEL ASSY		I7
604	2A		A60-2063-02	PANEL ASSY		I1
605	1A		A70-1286-05	REMOTE CONTROLLER ASSY		F1
605	1A		A70-1323-05	REMOTE CONTROLLER ASSY		I1I7
605	1A		A70-1324-05	REMOTE CONTROLLER ASSY		I5
605	1A		A70-1327-05	REMOTE CONTROLLER ASSY		P1
605	1A		A70-1362-05	REMOTE CONTROLLER ASSY		S1
610	2C		B07-2544-03	ESCUTCHEON		F1P1I1
610	2C		B07-2544-03	ESCUTCHEON		S1
-			B59-1442-00	SUB-INSTRUCTION MANUAL		P1
-			B60-4846-00	INSTRUCTION MANUAL		F1
-			B60-4847-00	INSTRUCTION MANUAL		P1
-			B60-4849-00	INSTRUCTION MANUAL		I1
-			B60-4850-00	INSTRUCTION MANUAL		S1
-			B60-4851-00	INSTRUCTION MANUAL		S1
-			B60-4852-00	INSTRUCTION MANUAL		I5
-			B60-4941-00	INSTRUCTION MANUAL		I7
△ 625	1A		E30-2917-05	CORD WITH CONNECTOR		F1
626	1A		E30-2948-05	AC POWER CORD (INLET)		
627	1A		E30-2975-05	CORD WITH CONNECTOR		
628	1A		E30-2976-05	CORD WITH CONNECTOR		I1I5I7
629	1A		E30-2996-05	CORD WITH CONNECTOR		P1S1
630	1B,2B		E35-2811-05	FLAT CABLE		
-			H10-7620-02	POLYSTYRENE FOAMED FIXTURE		F1P1I1
-			H10-7620-02	POLYSTYRENE FOAMED FIXTURE		S1
-			H10-7621-02	POLYSTYRENE FOAMED FIXTURE		F1P1I1
-			H10-7621-02	POLYSTYRENE FOAMED FIXTURE		S1
-			H10-7640-02	POLYSTYRENE FOAMED FIXTURE		I5
-			H10-7641-02	POLYSTYRENE FOAMED FIXTURE		I5
-			H12-3475-12	PACKING FIXTURE		I7
-			H13-0331-04	CARTON BOARD		F1P1I1
-			H13-0331-04	CARTON BOARD		S1I5
-			H13-0337-04	CARTON BOARD		I1I7
-			H25-0232-04	PROTECTION BAG (235X350X0.03)		
-			H25-1689-04	PROTECTION BAG		
-			H50-3525-04	ITEM CARTON CASE		I1
-			H50-3547-04	ITEM CARTON CASE		P1
-			H50-3658-04	ITEM CARTON CASE		S1
-			H50-3936-04	ITEM CARTON CASE		I5
-			H50-3956-04	ITEM CARTON CASE		F1
-			H50-4142-03	ITEM CARTON CASE		I7
650	2B,2C		J02-1493-03	FOOT ASSY		
651	1C		J19-3326-15	UNIT HOLDER		
-			J61-0307-05	WIRE BAND		

△ indicates safety critical components.

Model	Country	Tuner	Abb
DTF-3	France	X05-5172-70	F1
DTF-3	Poland	X05-5172-71	P1
DTF-3	Italy	X05-5172-72	I1
DTF-3	Spain	X05-5172-73	S1
DTF-103	Italy	X05-5172-74	I5
DTF-300	France	X05-5172-75	F3
DTF-300	Poland	X05-5172-76	P3
DTF-300	Italy	X05-5172-77	I3
DTF-300	Netherland	X05-5172-78	N3
DTF-300	Spain	X05-5172-79	S3
SMB 2700 PLUS	Italy	X05-5172-77	I7

* New Parts
 Parts without **Parts No.** are not supplied.
 Les articles non mentionnés dans le **Parts No.** ne sont pas fournis.
 Teile ohne **Parts No.** werden nicht geliefert.

3

Ref. No	Add-ress	New Parts	Parts No.	Description	Desti-nation	Re-marks
670	1A		W01-0978-05	ADAPTER	P1	
671	1A		W01-0986-15	ADAPTER	S1	
673	1C		W02-2767-05	ELECTRIC CIRCUIT MODULE		
680	1B		X05-5172-70	TUNER UNIT	F1	
680	1B		X05-5172-71	TUNER UNIT	P1	
680	1B		X05-5172-72	TUNER UNIT	I1	
680	1B		X05-5172-73	TUNER UNIT	S1	
680	1B		X05-5172-74	TUNER UNIT	I5	
680	1B		X05-5172-77	TUNER UNIT	I7	
681	2B		X14-7242-70	DISPLAY UNIT		
TUNER (X05-5172)						
J1			E63-0122-05	PIN JACK	F1P111	
J1			E63-0122-05	PIN JACK	S115	
J1			E63-1168-05	PIN JACK	F3P313	
J1			E63-1168-05	PIN JACK	I7N3S3	
J2			E58-0031-05	RECTANGULAR RECEPTACLE		
J3			E68-0008-05	MODULAR JACK		
J4			E58-0025-05	RECTANGULAR RECEPTACLE		
J5			E58-0026-05	RECTANGULAR RECEPTACLE		
A1			W02-2764-05	TUNER ASSY		
A2			W02-1114-15	OSCILLATING MODULE	F3P313	
A2			W02-1114-15	OSCILLATING MODULE	I7N3S3	
DISPLAY (X14-7242-70)						
J1			E68-0007-05	JACK(OTHERS)		
J2			E68-0006-05	JACK(OTHERS)		
A1			W02-2670-05	OPTIC RECEIVING MODULE		
A1			W02-2804-05	OPTIC RECEIVING MODULE		

PARTS LIST

DTF-3/103/300

⚠ indicates safety critical components.

KENWOOD CORPORATION

14-6,Dogenzaka 1-chome, Shibuya-ku, Tokyo, 150-8501 Japan

KENWOOD SERVICE CORPORATION

P.O BOX 22745, 2201 East Dominguez St., Long Beach, CA 90801-5745, U.S.A.

KENWOOD ELECTRONICS CANADA INC.

6070 Kestrel Road, Mississauga, Ontario, Canada L5T 1S8

KENWOOD ELECTRONICS LATIN AMERICA S.A.

P.O BOX 55-2791, Piso 6 plaza Chase, Cl. 47 y Aquilino de la Guardia Panama, Republic de Panama

KENWOOD ELECTRONICS BRASIL LTDA.

Av. Moema, 170-17, Andar-Cobertura "B", Ed. Maximum Service Center, 04077-020 Moema, São Paulo-SP-Brasil

KENWOOD ELECTRONICS U.K. LIMITED

KENWOOD House, Dwight Road, Watford, Herts., WD1 8EB., United Kingdom

KENWOOD ELECTRONICS BELGUM N.V.

Meachelsesteenweg 418, B-1930 Zaventem, Belgium

KENWOOD ELECTRONICS DEUTSCHLAND GMBH

Rembrücker Str. 15, 63150 Heusenstamm, Germany

KENWOOD ELECTRONICS FRANCE S.A.

13 Boulevard Ney, 75018 Paris, France

KENWOOD ELECTRONICS ITALIA S.p.A.

Via G. Sirtori, 7/9 20129, Milano, Italy

KENWOOD IBÉRICA S.A.

Bolivia, 239-08020 Barcelona, Spain

KENWOOD ELECTRONICS AUSTRALIA PTY. LTD.

(A.C.N. 001 499 074)

16 Giffnock Avenue, North Ryde, N.S.W. 2113, Australia

KENWOOD ELECTRONICS (HONG KONG) LTD.

Unit 3712-3724, Level 37, Tower 1, Metroplaza, 223 Hing Fong Road, Kwai Fong N.T., Hong Kong

KENWOOD ELECTRONICS GULF FZE

P.O.Box 61318, Jebel Ali, Dubai, U.A.E.

KENWOOD ELECTRONICS SINGAPORE PTE LTD.

No. 1 Genting Lane #02-02, KENWOOD Building, Singapore, 349544

KENWOOD ELECTRONICS (MALAYSIA) SDN BHD.

#4.01 Level 4, Wisma Academy Lot 4A, Jalan 19/1 46300 Petaling Jaya Selangor Darul Ehsan Malaysia

KENWOOD ELECTRONICS (THAILAND) CO., LTD.

2019 New Pechburi Road, Bangkapi, Huaykwang, Bangkok, 10320 Thailand